

Dried-down Reagents on a Microfluidic Chip for LATE-PCR Amplification and Detection of Single-stranded DNA

Yanwei Jia,^{a,b} Pui-In Mak,^b Conner Massey,^a Rui P. Martins,^{b,c} and Lawrence J. Wangh*^a

^a Department of Biology, Brandeis University, 415 South Street, Waltham MA 02454, US

^b State-Key Laboratory of Analog and Mixed-Signal and FST-ECE, Univ-ersity of Macau, Avenida Padre Tomás Pereira, Taipa, Macao, China

^c on leave from Instituto Superior Técnico, Technical University of Lisbon, Portugal

LATE-PCR

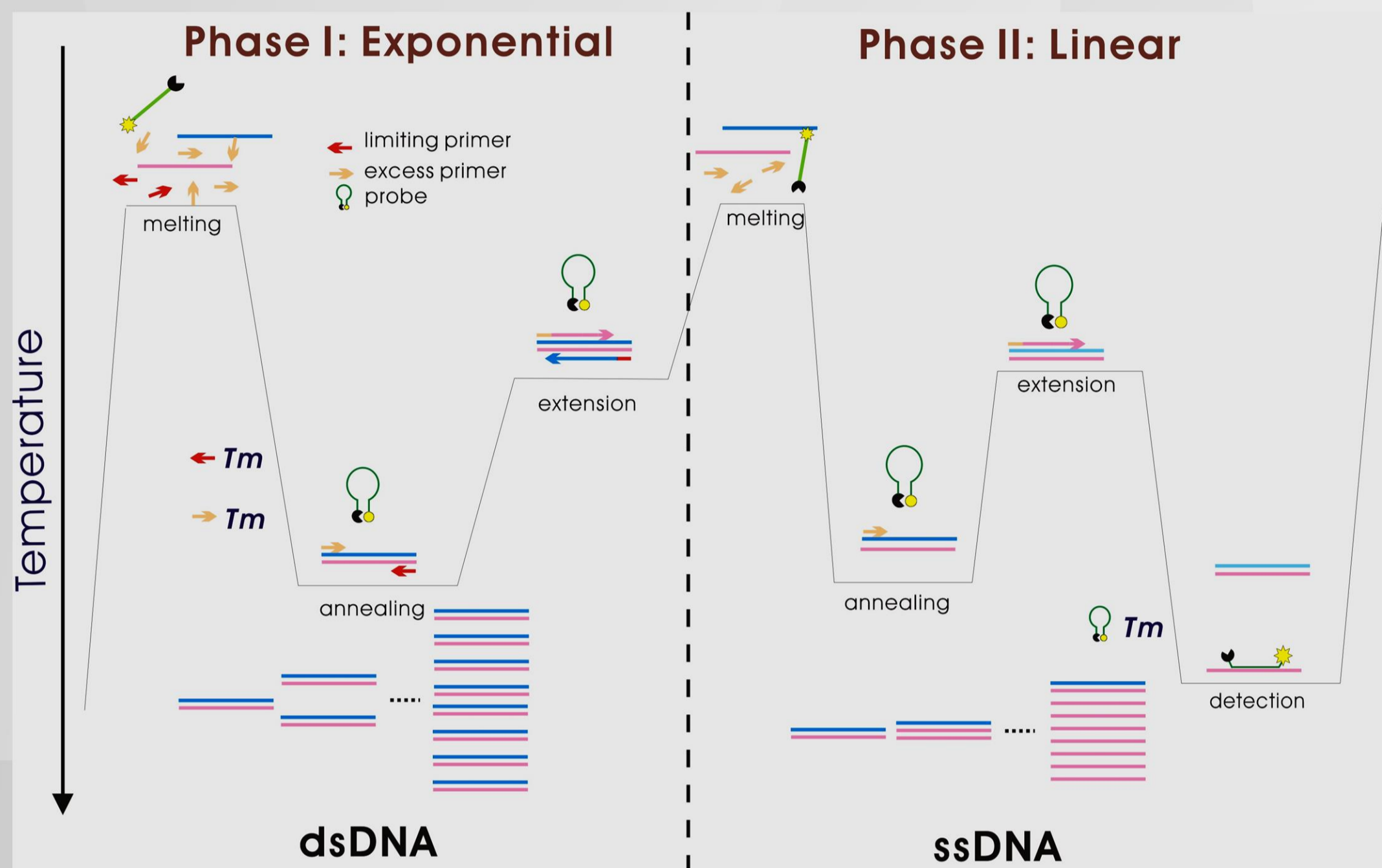

Objectives

Now
25 μ L tube

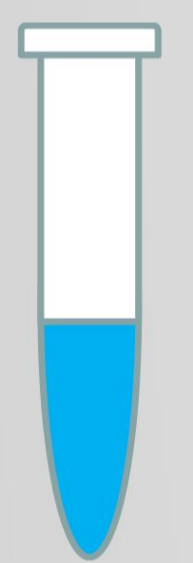

Future
1 nL well

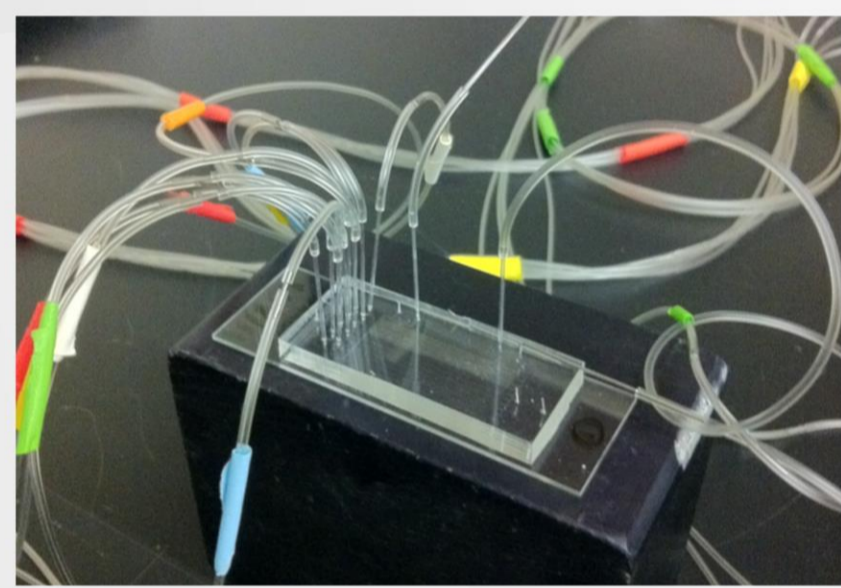

Experimental Design

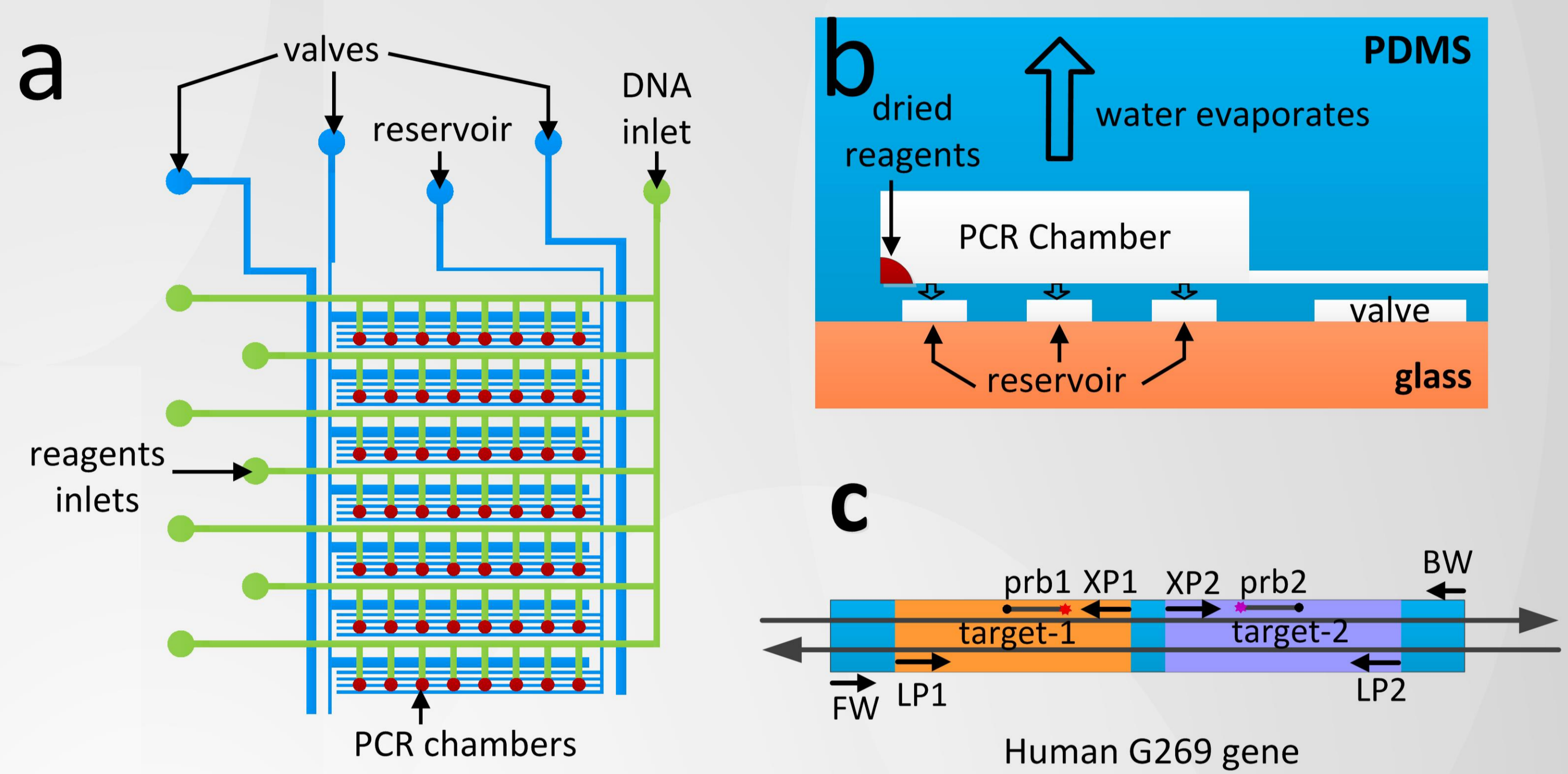

How Fast Dried Reagents Resuspend?

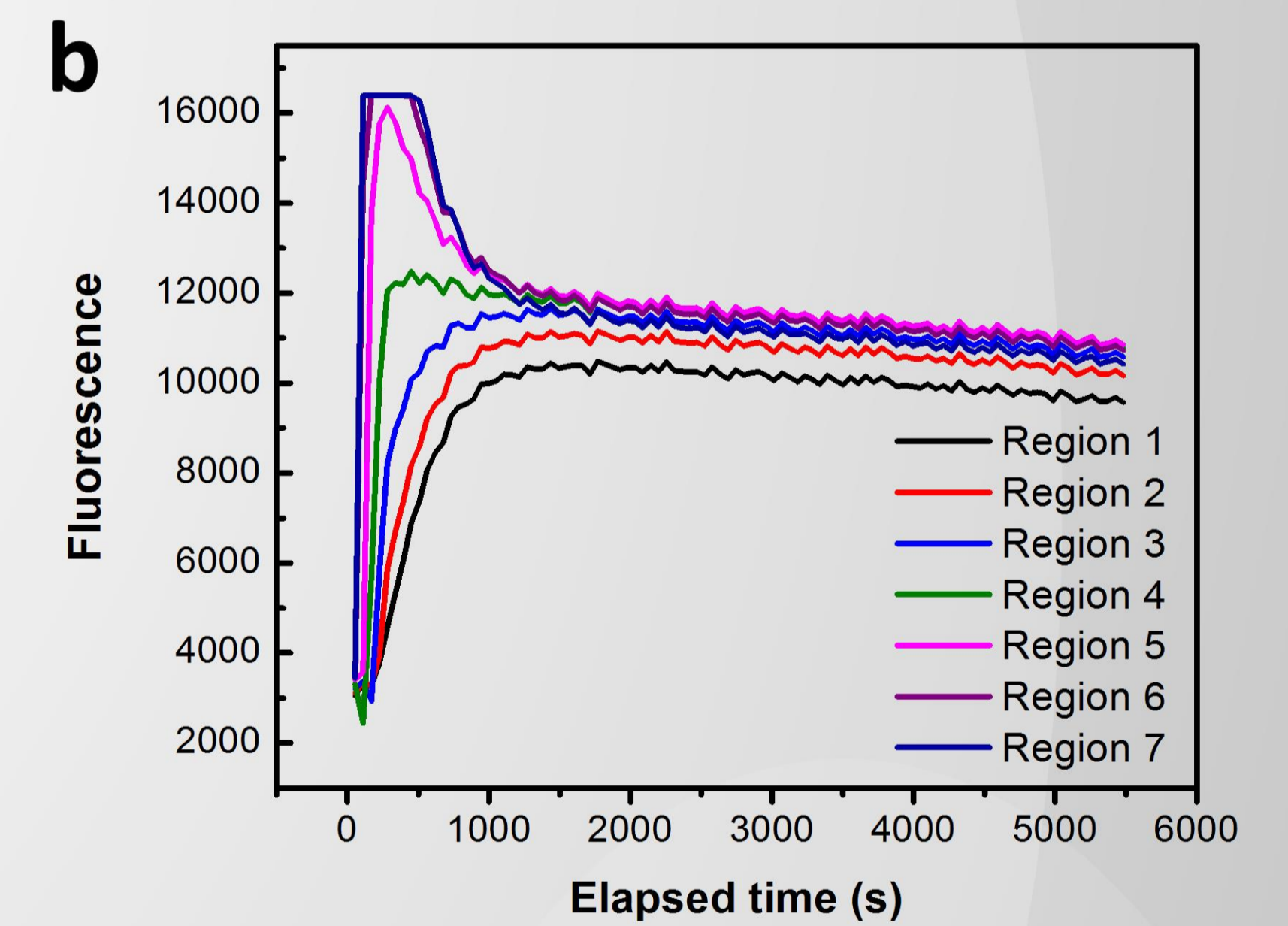
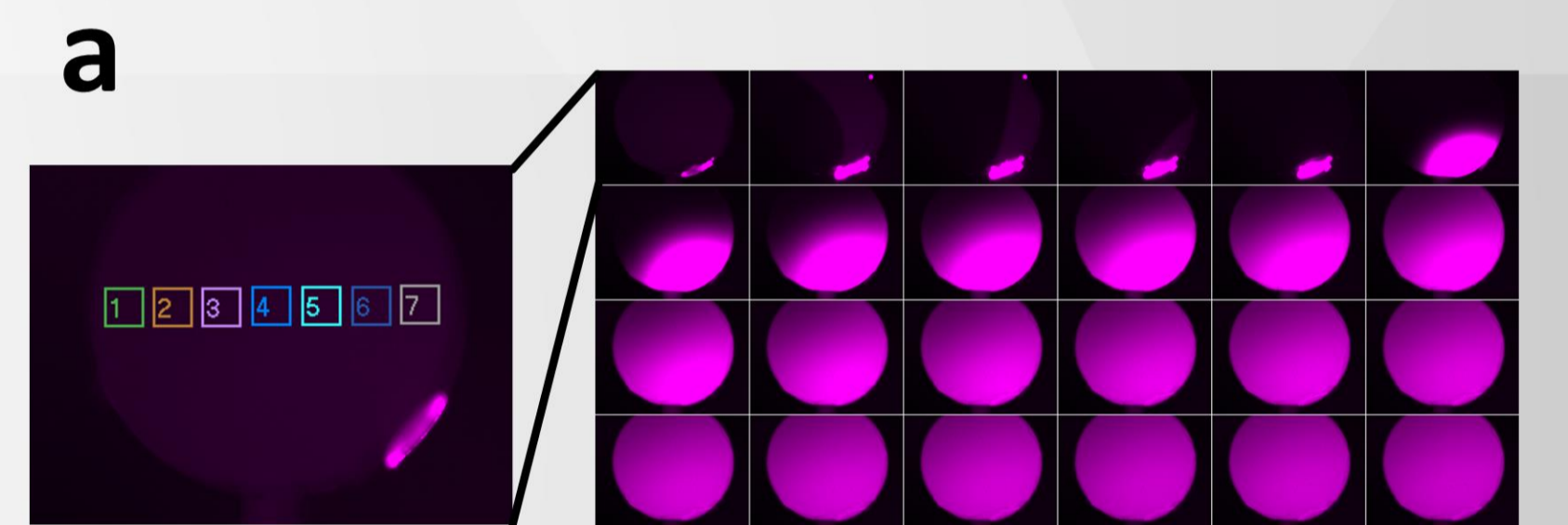

Additive Reagents for Drying and Resuspending

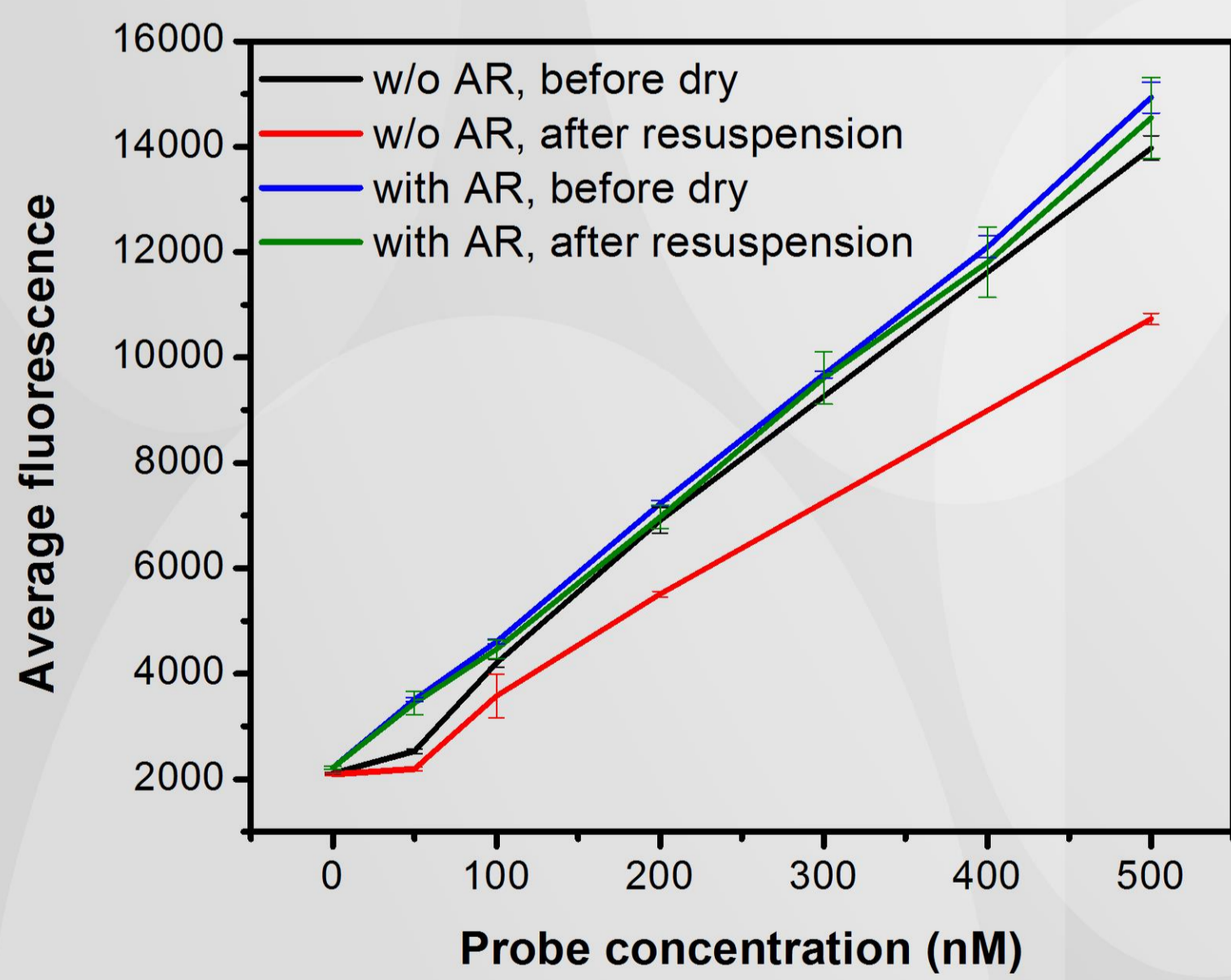

What can be Dried?

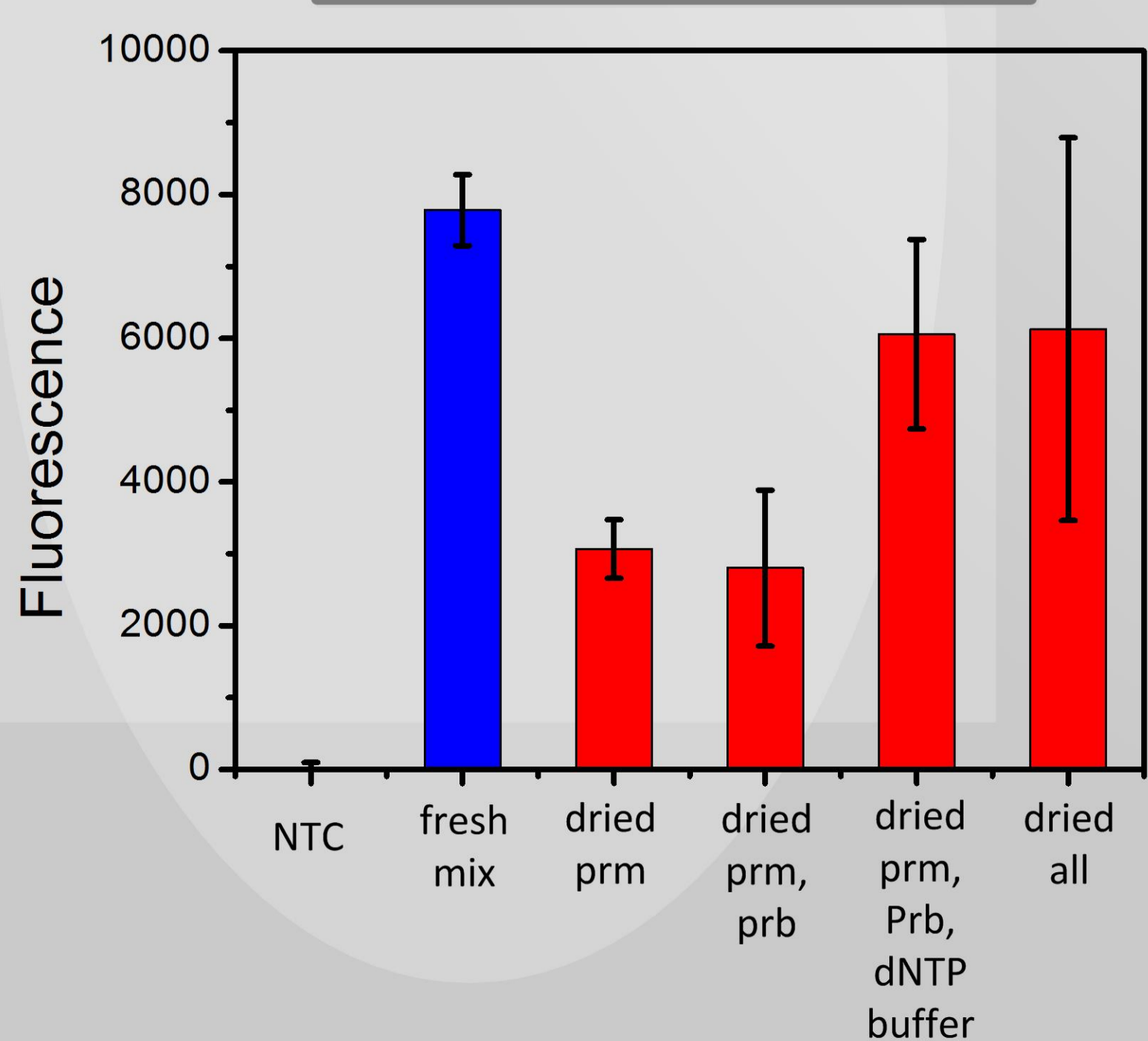

Taqman Probe vs. Molecular Beacon Probe

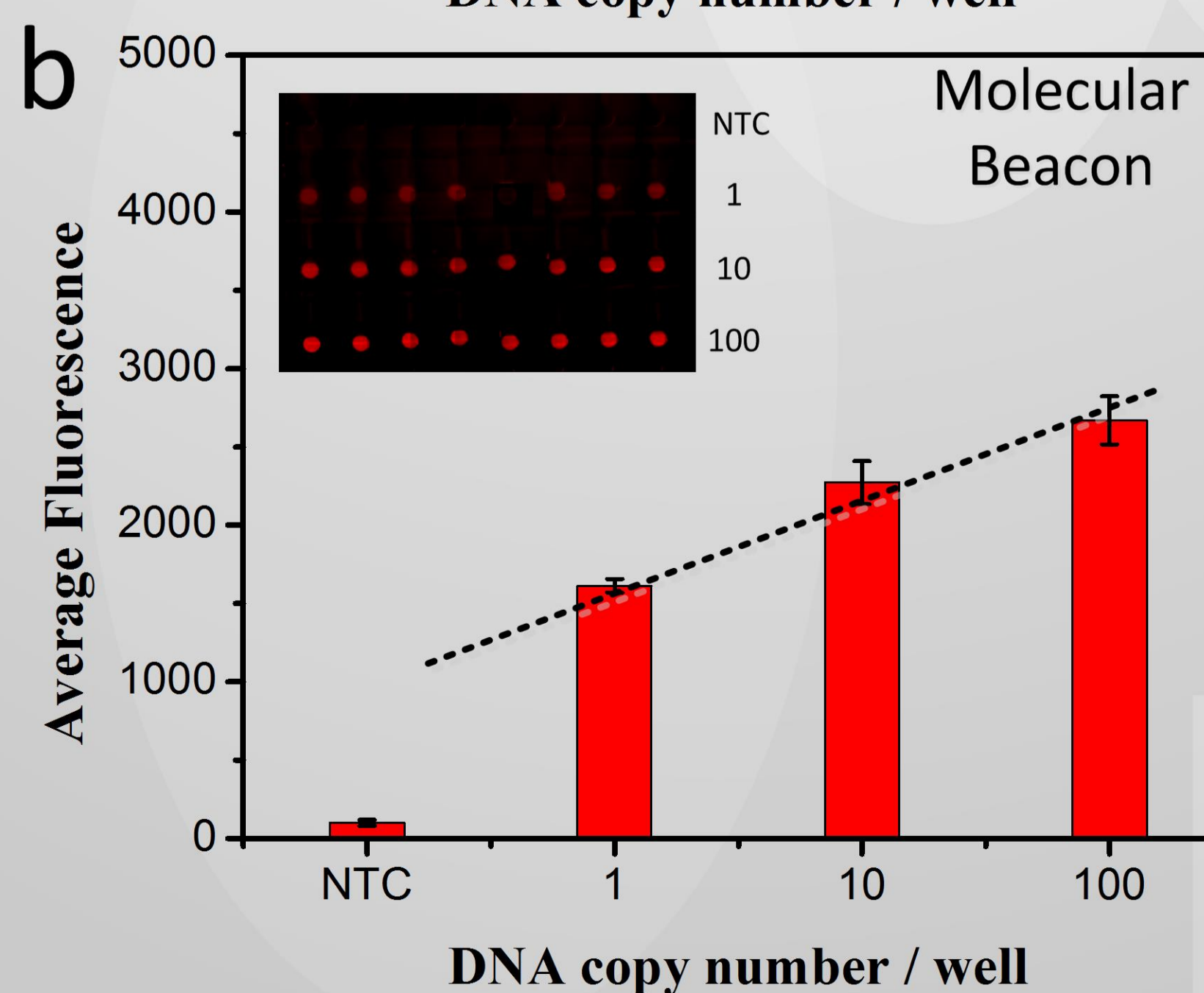
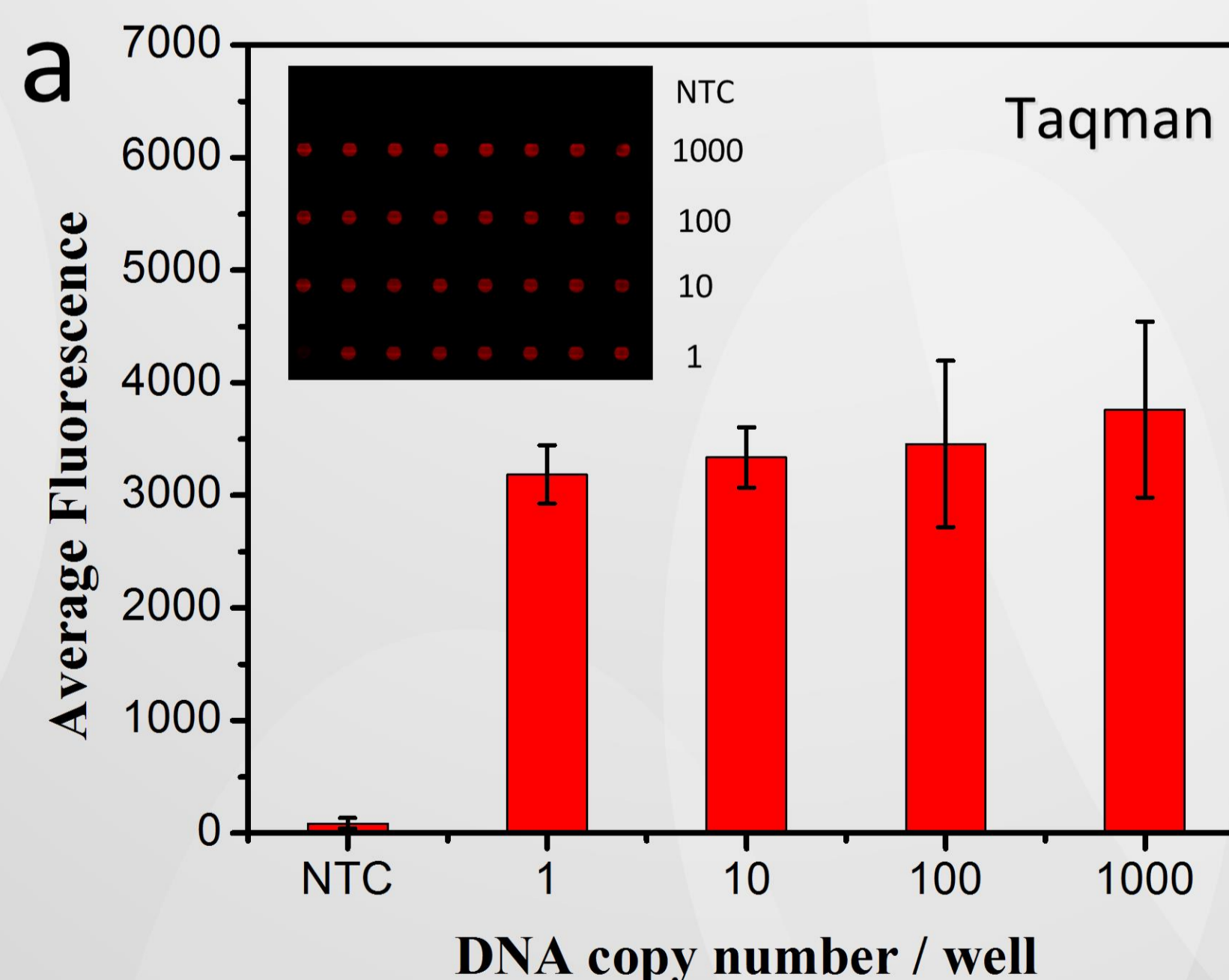

Multiplex Competition

