

# A Double Active-Decoupling Technique for Reducing Package Effects in a Cognitive-Radio Balun-LNA

Miao Liu, Pui-In Mak, Yao-Hua Zhao and R. P. Martins<sup>1</sup>

State-Key Laboratory of Analog and Mixed-Signal VLSI, University of Macau, Macao, China (E-mail: [pimak@umac.mo](mailto:pimak@umac.mo))

<sup>1</sup> – On leave from Instituto Superior Técnico (IST) / TU of Lisbon, Portugal

**Abstract**—Package effects degrade the performances of high frequency circuits such as wideband low-noise amplifiers (LNAs). This paper describes an area-saving technique to improve the performance of a balun-LNA covering the range of 50 MHz to 10 GHz in the presence of package effects. A double active-decoupling technique based on a feedback inverter amplifier is proposed. Optimized in GP 65-nm CMOS, the new technique shows 2.3-dB maximum gain loss compensation, 6.6GHz bandwidth recovery for input matching, and 22-dB maximum noise filtering in both supply rails. The added active circuitry draws 16 mW from a single 1.2-V supply, and the required physical capacitor is reduced to 4 pF.

## I. INTRODUCTION

Cognitive radios (CRs) have become the RF design trend for its efficiency and flexibility of utilizing any unoccupied channels in a wide frequency range [1]. However, it is an enormous challenge to balance all levels of abstraction. The low noise amplifier (LNA) is the first stage in the receiver path, and its behavior significantly affects the performance of the whole system. Two key design issues of LNA are: (1) broadband characteristic, i.e., the relatively flat noise figure (NF) and gain, and adequate input matching across the signal band, 50MHz to 10GHz for our case, and (2) nonlinearity.

A LNA topology introduced in [1] has employed a three-stage common source (CS) amplifier in cascade with a resistive feedback. It exploits inductive input impedance of the negative feedback to cancel the input capacitance, which has achieved an optimized trade-off between the input matching, NF and bandwidth (BW). As described in [1], for CRs, the wideband LNA is likely to be the bottleneck in terms of the linearity. IP2 would be the worst among all, since the other IM products of the system can be superposed to the desired channel. Differential outputs may cancel the even order harmonics, thus improving the IP2; however for the case when the antenna is single-ended, a balun would be needed. In [1], the output is sensed between the last two stages. Based on this pseudo-differential sensing, the signal is partially cancelled, and the gain and IP2 are both increased. However, the nonlinearity cancelation relies on the gain and phase matching between the two outputs and they always vary with frequency.

Based on our previous work [2], an RC degeneration circuit adding to the last CS stage is proposed as shown in Fig. 1. The RC degeneration can lower down the gain of the third stage, as well as provides better matching between the two output nodes, besides it can improve the linearity [2]. The degeneration capacitor  $C_{deg}$  also effectively boosts up the BW of the balun LNA.

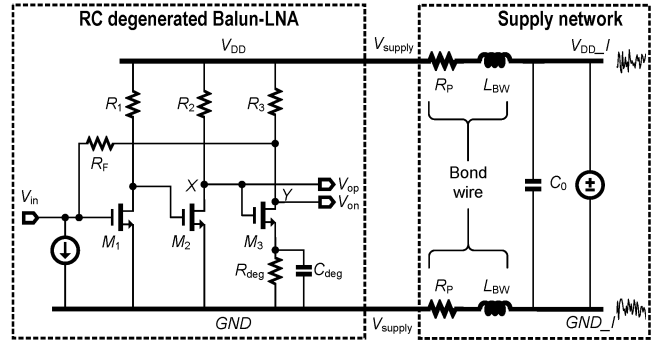

Fig. 1. RC-degenerated balun-LNA and practical supply network model.

This RC degenerated balun LNA has achieved favorable performance, however, only in “ideal” circumstances. With package parasitics involved, signal loss will occur in high-frequency, eventually introducing a NF decrease and an input matching BW reduction. Besides, as the transistor dimension scales down, the supply voltage and the noise might give rise to a drawback in terms of circuit design [3]. A double active-decoupling technique (active decaps) is proposed in this paper to reduce the sensitivity of the balun-LNA to package effects. Specifically, this technique improves the gain loss and input matching, and offers noise filtering to both supply rails.

## II. PROPOSED DOUBLE ACTIVE-DECOUPLING TECHNIQUE

The power supply including package parasitics can be modeled by the “supply network” of Fig. 1.  $V_{DD\_I}$  and  $GND\_I$  are the power supply terminals without package parasitics which may contain noise.  $V_{DD}$  and  $GND$  represent the power supply with package parasitics.  $V_{supply}$  denotes either  $V_{DD}$  or  $GND$ , which is the supply rail voltage.  $L_{BW}$  is the inductance resulting mainly from the bond wires,  $R_P$  is the parasitics resistance of the supply network, and  $C_0$  denotes the on-chip intrinsic circuit capacitance.  $L=0.4$  nH,  $R=0.2\Omega$  and  $C_0=200$  pF are chosen as in [3].

For the LNA operating at very high frequency, the output signals  $V_{op}$  and  $V_{on}$  will vary with the input signal frequency, so it does the signal current flowing through nodes X and Y, consequently. With the package effects taken into account, the  $V_{supply}$  voltage will vary with frequency. For simplicity, the package effects will be analyzed by just considering the bond wire inductance  $L_{BW}$ .

As shown in Fig.2 (a), an ideal voltage source connected by the bond wire inductance represents the voltage source with package parasitics  $V_{supply}$ , and the ac current source

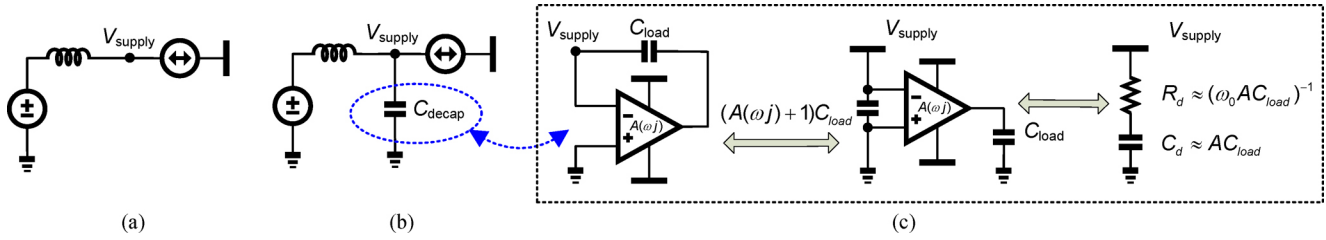

Fig. 2. (a) Circuit performance degradation due to package parasitics, (b) package effects cancellation by decaps, (c) active decaps principle.

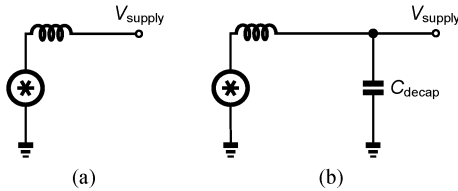

Fig. 3. (a) Noisy power supply in the presence of package inductance, (b) noise suppression by applying decaps.

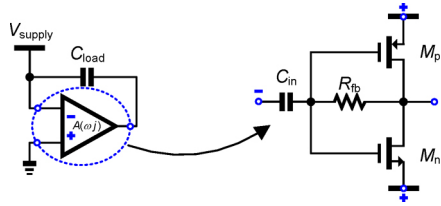

Fig. 4. Schematic of proposed active decap circuit.

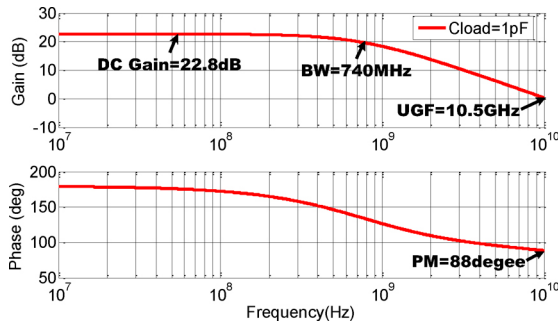

Fig. 5. Simulated bode plot of the active decap opamp.

denotes the signal current. A small capacitance can be seen from  $V_{supply}$  in any practical circuit, together with bond wire inductance  $L_{BW}$ , they will form a LC circuit with a time constant  $\tau=1/(LC)$ . As the frequency of the signal current increases, the effective supply voltage will decrease, and this will lead to gain degradation of the LNA in high frequency.

In order to stabilize the frequency-varying power supply, a capacitor is required to be applied to  $V_{supply}$  for decreasing the time constant, and thus to cancel the package inductance. Conventionally, passive decoupling capacitor (passive decaps) is used as shown in Fig. 2 (b). It is predicted that the variation of  $V_{supply}$  will be suppressed down very quickly if a relatively large capacitor is used.

Active decoupling capacitor (active decaps) circuit has been introduced in [3] and [4] to suppress the substrate noise in mixed-signal integrated circuits, which employs the Miller effect to boost the effective decap value. Fig. 2 (c) shows

the principle of using Miller effect for decap boosting. The negative input and the output terminals of an operational amplifier (opamp) are connected with a capacitor  $C_{load}$ , and the positive input of the opamp is connected to virtual ground. The two voltage supplies of the opamp are generated locally, and are supposed to be precisely 1.2V and 0V, respectively. Then the equivalent capacitance seeing from  $V_{supply}$  will be boosted by a factor of  $(1+A(j\omega))$ , where  $A(j\omega)$  represents the gain of the opamp, and varies with frequency  $\omega$ .

Assuming that the opamp used in the active decap circuit is single stage with a dc gain of  $A$  and a dominant pole at  $\omega_0$ , then the transfer function of this opamp can be formulated by  $A(\omega j)=A/(1+\omega j/\omega_0)$ . It would be more intuitive to analyze the active decaps by modeling it through its passive equivalent. Due to the band-limited property of the active opamp, the gain will drop beyond its BW, thus the active decaps can be replaced by a series connected resistor  $R_d$  and capacitor  $C_d$  as shown in Fig. 2 (c). The effective capacitance is  $A \cdot C_{load}$ . And the effective resistance  $R_d$  can be found by equating the impedance of  $A(\omega j) \cdot C_{load}$  with the impedance of the series connected  $R$  and  $C$  as in (1):

$$\begin{aligned} Z(A(\omega j) \cdot C_{load}) &= 1/[A/(1+\omega j/\omega_0) \cdot C_{load} \cdot \omega j] \\ &= Z(R_d) + Z(A \cdot C_{load}) \\ &= R_d + 1/(A \cdot C_{load} \cdot \omega j) \end{aligned} \quad (1)$$

Thus the effective resistance is  $R_d = 1/(\omega_0 \cdot A \cdot C_{load})$ . The active decaps technique will avoid large peaking caused by bond wire inductance and decaps due to this resistance, a big advantage compared to passive decaps. And, active decaps saves more chip area than passive decaps; with a much smaller capacitor when comparing it with its passive counterpart. However, the opamp used in the active decaps consumes power. So, if a small capacitor and a reasonable power consumption opamp is used, a large unpractical passive decaps could be avoided. Besides, as mentioned in [3], a large passive capacitor may introduce significant leakage problems. And with the downscaling of technology, active decaps will be more attractive.

As mentioned in [2], the balun-LNA with RC degeneration is very sensitive to supply line noise, especially for ground rail noise. And it will be proved that applying decaps also helps to suppress the supply line noise in the presence of package effects. Fig. 3(a) shows the supply line with package inductance. For a noisy power supply, there is no noise suppression at node  $V_{supply}$ . In Fig. 3(b), after

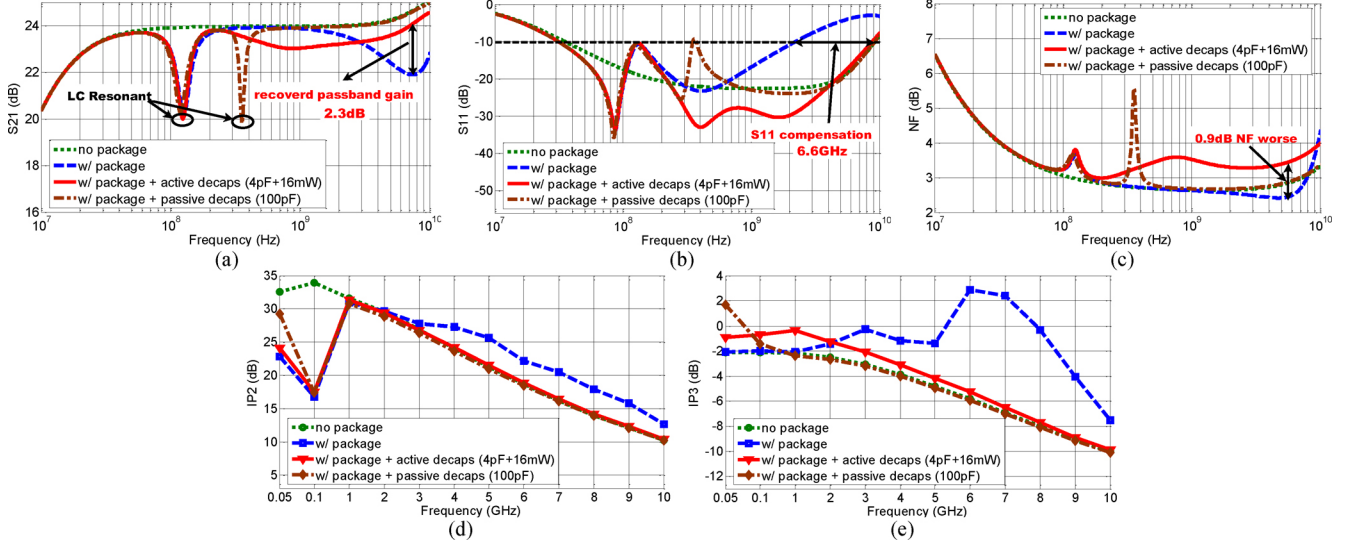

Fig. 6. Simulation results for (a) S21, (b) S11, (c) NF, (d) IP2, (e) IP3.

applying decaps to the supply line, noise will be suppressed down very effectively. In order to comprehensively reduce the supply line noise, a double active-decoupling technique is applied to the balun-LNA. One is for the  $V_{DD}$ , the other is for the GND; both are to cancel the parasitic inductance and improve the noise filtering to achieve better performances.

For the opamp used in the active decaps, there will be the following considerations: (1) very wide BW to reduce package parasitics effectively across the wideband signal range, e.g. 10 GHz GBW, (2) large gain to boost up the decaps more effectively and to save more area, (3) reasonable power consumption, and (4) simple structure. Finally, the inverter with resistive feedback is proposed as the opamp selection shown in Fig. 4. The negative input terminal will be connected to the  $V_{supply}$  to sense the supply line noise, and the positive input terminal will be connected to the two supplies of the opamp, namely the source terminals of  $M_p$  and  $M_n$ , as the virtual ground terminal. An input capacitor  $C_{in}$  is required to couple the supply signal to the opamp. The value of  $C_{in}$  should be much larger than the sum of  $C_{gg\_NMOS}$  and  $C_{gg\_PMOS}$ , in order to avoid signal loss due to voltage dividing. Here  $C_{in}$  is chosen to be 1 pF.

The gain and the GBW of the opamp can be formulated as in (2) and (3). This opamp has large gain and GBW due to the relatively large equivalent transconductance  $G_m$ , and it does not need any bias circuit. It is simple, effective and stable. The above properties are just adequate for the design.

$$A_v = \frac{1 - R(g_{m_n} + g_{m_p})}{1 + R/(r_{on} \parallel r_{op})} \approx -(g_{m_n} + g_{m_p}) \times (r_{on} \parallel r_{op}) \quad (2)$$

$$GBW = \frac{G_m}{C_{load}} = \frac{g_{m_n} + g_{m_p}}{C_{load}} \quad (3)$$

Then, an opamp design example was implemented. It has a DC gain of 22.8 dB, bandwidth of 740 MHz, unity gain frequency of 10.5 GHz and phase margin of  $88^\circ$  with 1 pF load capacitor under 8 mW of power. The resulting

performances are shown in Fig. 5. As defined by (1) and (2), better performances can be obtained with larger power budget, so this opamp reveals itself quite adequate for the related applications.

### III. SIMULATION RESULTS

The results based on circuit-level simulations are presented in Fig. 6(a)-(e) and Fig. 7(a) and (b): i) “no package” represents the simulation results for the LNA under the power supply without any package effects; ii) “w/ package” stands for the power supply with package effects. Referring back to Fig. 1, the package effects are modeled by the simple RLC circuits with  $L = 0.4$  nH,  $R = 0.2$   $\Omega$ , and  $C_0 = 200$  pF; iii) “w/ package + active decaps (4 pF + 16 mW)” is the case where the power supply with package effects and with active decaps are applied. The double active decaps draws a total power of  $2 \times 8$  mW and consumes a total capacitance of  $2 \times (1+1)$  pF for the input and load; iv) “w/ package + passive decaps (100 pF)” is the case where the power supply with package effects and with passive decaps are applied, which consumes a total capacitance of  $2 \times 50$  pF. To avoid large peaking at the resonant frequency caused by the passive decaps a  $2 \times 0.5$   $\Omega$  resistor is utilized.

#### A. The gain of the balun-LNA (S21)

As mentioned before, when the frequency increases the impedance of the supply rails will follow it, which will cause gain degradation. Active decaps cancels the inductance effects of the supply lines, which, on the other hand, compensates the gain degradation of the LNA, as shown in Fig. 6(a). The gain performance has no degradation without supply package parasitics, and degrades in high frequency with the package parasitics taken into account. After applying decaps to the supply lines, the signal loss is compensated, and there is a peaking at approximately 140 MHz for all the cases with supply package considered. This, corresponds to a resonant frequency caused by supply

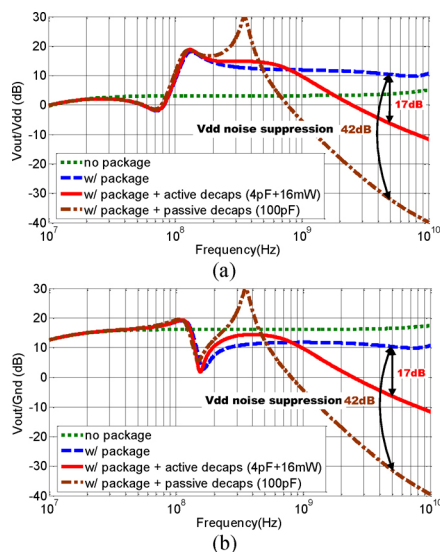

Fig. 7. Noise filtering performances for (a) voltage supply, (b) ground.

package parasitics, and can be reduced by adding a resistor to the supply lines. However the resistor may divide the supply voltage, thus leading to power supply degradation. There is another large peaking at around 350 MHz for passive decaps only. It is the LC resonant frequency caused by the supply line inductance and passive decaps, which can also be suppressed by adding resistors. The resistor may degrade the performance of decoupling and add noise. The peaking is avoided in the proposed active decaps technique due to its intrinsic series resistance.

### B. The input matching ( $S_{11}$ )

The impedance of the antenna is assumed to be  $50 \Omega$ . It is challenging to match this over a wide range of frequency. If the open loop transfer function of the LNA is modeled as a one-pole system for simplicity, the input admittance will behave like in Fig. 8. It is shown that the gain enhancement of the LNA will lower down  $1/\text{Re}\{Y_1\}$  and boost up  $-\text{Im}\{Y_1\}$ . So, better input matching will be obtained with gain enhancement. Fig. 6(b) shows the input matching performances for the above four types of supplies. As predicted, after package effects are involved, the effective BW is reduced to 1.5 GHz. This is unacceptable in our LNA design. By applying decaps, the BW will recover and due to the large peaking caused by the supply inductance and decaps, passive decaps shows a worse performance when compared with its active counterpart at mid frequency.

### C. Noise figure (NF) and linearity

With the gain improved, the NF will be suppressed down theoretically, since the input referred noise is equal to the total noise divided by the gain. However, the opamp used in the active decaps will introduce additional noise, so for better performance, the noise of the opamp should be minimized. The simulated NF performances are shown in Fig. 6(c). Active decaps add some noise to the whole circuit,

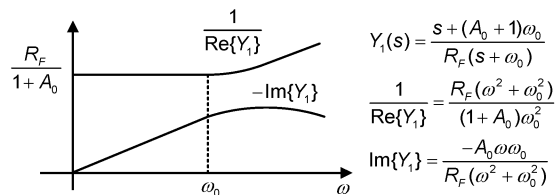

Fig. 8. Behavior of  $Y_1$  components with frequency.

but since the gain has been improved by decaps, there is only 0.9-dB maximum NF degradation.

As shown in Fig. 6(d) and (e), after applying decaps, the linearity is quite unaffected.

### D. Noise filtering

Noise from outside supplies will be suppressed effectively in high frequency by decaps due to inductance canceling for both supply lines. The noise filtering performances are shown in Fig. 7. Since the same decaps is applied to both of the supply lines, the noise suppression performance is the same for  $V_{DD}$  and GND.

## IV. CONCLUSIONS

A double active-decoupling technique based on an inverter resistive feedback opamp is proposed to reduce package effects for cognitive radio balun-LNA in GP 65-nm CMOS process. The design example employs two active decaps that have achieved a 2.3-dB maximum gain loss compensation, 6.6-GHz BW recovery for input matching, 22-dB noise suppressions for both supply lines with 4-pF capacitance and 16-mW power consumption. The simulation results are compared to passive decaps, considering a 100-pF capacitance. It is shown that the active decoupling technique is much more area-efficient and can avoid large peaking which is harmful to circuit performances.

### ACKNOWLEDGEMENT

This work was supported by the Research Committee of University of Macau, and Macao Science and Technology Development Fund (FDCT).

### REFERENCES

- [1] B. Razavi, "Cognitive Radio Design Challenges and Techniques," *IEEE J. Solid-State Circuits*, vol. 45, no. 8, Aug. 2010.
- [2] W.-F. Cheng, K.-F. Un, P.-I. Mak and R. P. Martins, "A Highly-Linear Ultra-Wideband Balun-LNA for Cognitive Radios," *IEEE International Conference on Computer as a Tool (EUROCON)*, pp. 1-4, April 2011.
- [3] J. Gu and R. Harjani, "Design and Implementation of Active Decoupling Capacitor Circuits for Power Supply Regulation in Digital ICs," *IEEE Tran. On Very Large Scale Integration (VLSI) Systems*, vol. 17, no. 2, pp. 292-301, Feb. 2009.
- [4] T. Tsukada *et al.*, "An on-chip active decoupling circuit to suppress crosstalk in deep-submicron CMOS mixed-signal SoCs," *IEEE J. of Solid-State Circuits*, vol. 40, no. 1, pp. 67-79, Apr. 2005.